

KARTA PRODUKTU

Numer Katalogowy	761259202
Dane Techniczne	
Pojemność (Ah)	125Ah
Napięcie (V)	12V
Prąd rozruchowy (A)EN	920
Długość (mm) [L]	344
Szerokość (mm) [W]	175
Wysokość (mm) [H]	233
Waga (kg) +/- 10%	24,5
Układ połączeń	2 (Prawo +)
Końcówki	1
Mocowanie	B01
Wskaźnik naładowania	x
Prąd ładowania	Ok. 1/10 pojemności znamionowej
Napięcie ładowania	14,8 V
Typ/ Technologia	Kwasowo-ołowiowy (Ca-Ca) / X-Classe

*DOMYŚLNY ZAMIENNIK Varta: - (Sprawdź)

MASTER-SPORT Automobiltechnik (MS) GmbH
Leopoldstr. 244 80807 München
Tel: +48 18 35 35 475 E-mail: sekretariat@master-sport.de



ISO 9001



ISO IATF 16949*



CERTIFIED



AEO



CERTIFIED



www.tecdoc.de



www.teccom.de

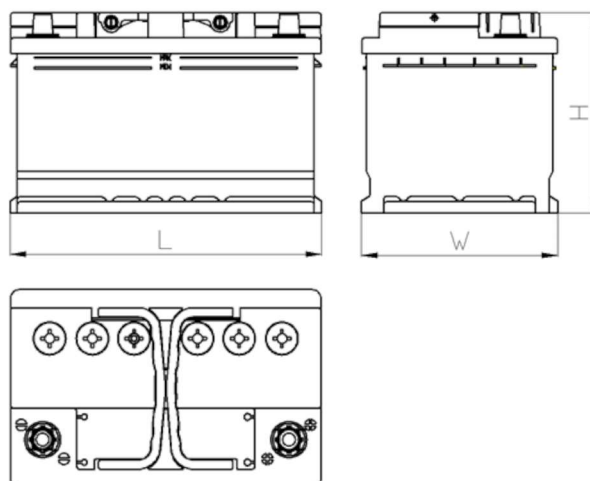

TECHNICAL DATA SHEET

Catalog number	761259202
TECHNICAL DATA	
Capacity (Ah)	125Ah
Voltage (V)	12V
Cold cranking performance (A)EN	920
Length (mm) [L]	344
Width (mm) [W]	175
Height (mm) [H]	233
Weight (kg) +/- 10%	24,5
Connection layout	2 (Right +)
Tips	1
Base hold-down	B01
Charge indicator	x
Charging current	Approx. 1/10 Rated Capacity
Charging voltage	14,8 V
Type / Technology	Lead-Acid (Ca-Ca) / X-Classe

*DEFAULT REPLACEMENT Varta: - (Check)

MASTER-SPORT Automobiltechnik (MS) GmbH
Leopoldstr. 244 80807 München
Tel: +48 18 35 35 475 E-mail: sekretariat@master-sport.de



ISO 9001



ISO IATF 16949*



CERTIFIED



AEO



CERTIFIED



www.tecdoc.de



www.teccom.de

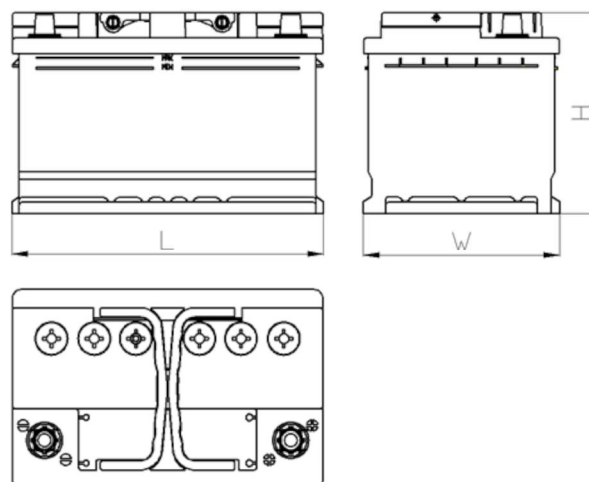

TECHNISCHES DATENBLATT

Nummer	761259202
TECHNISCHE DATEN	
Nennkapazität (Ah)	125Ah
Nennspannung (V)	12V
Kaltstartstrom (A)EN	920
Länge (mm) [L]	344
Szerokość (mm) [W]	175
Höhe (mm) [H]	233
Batteriegewicht (kg) +/- 10%	24,5
Polausführung	2 (Rechts +)
Schaltung	1
Bodenleiste	B01
Ladeanzeige	x
Ladestrom	Ca. 1/10 Nennkapazität
Ladespannung	14,8 V
Typ / Technologie	Blei-Säure-Batterie (Ca-Ca) / X-Classe

*STANDARD-ERSATZ Varta: - (Scheck)

MASTER-SPORT Automobiltechnik (MS) GmbH
Leopoldstr. 244 80807 München
Tel: +48 18 35 35 475 E-mail: sekretariat@master-sport.de



ISO 9001



ISO IATF 16949*



CERTIFIED



AEO



CERTIFIED



www.tecdoc.de



www.teccom.de

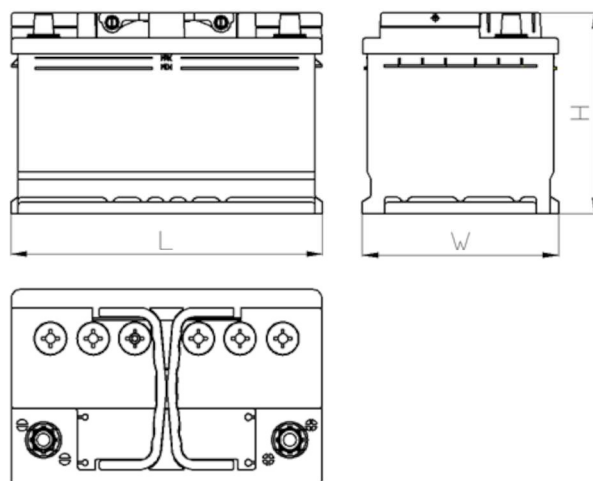

SCHEDA PRODOTTO

Numero di catalogo	761259202
Dati tecnici	
Capacità (Ah)	125Ah
Tensione (V)	12V
Spunto (A)EN	920
Lunghezza (mm) [L]	344
Larghezza (mm) [W]	175
Altezza (mm) [H]	233
Peso (kg) +/- 10%	24,5
Sistema di connessione	2 (Destra +)
Estremità	1
Montaggio	B01
Indicatore di carica	x
Corrente di carica	Circa 1/10 Capacità nominale
Tensione di carica	14,8 V
Tipo / Tecnologia	al Piombo-Acido (Ca-Ca) / X-Classe

*Sostituto Varta: - (Controllare)

MASTER-SPORT Automobiltechnik (MS) GmbH
Leopoldstr. 244 80807 München
Tel: +48 18 35 35 475 E-mail: sekretariat@master-sport.de



ISO 9001



ISO IATF 16949*



CERTIFIED



AEO



CERTIFIED



www.tecdoc.de



www.teccom.de

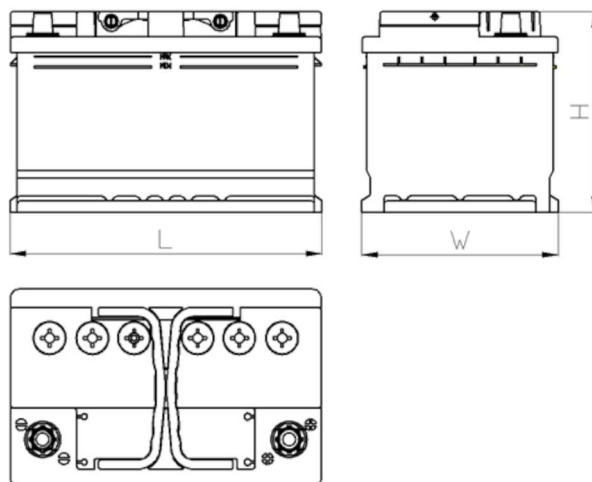

Технические характеристики

Каталожный номер	761259202
Технические данные	
Емкость (Ач)	125Ah
Напряжение (В)	12V
Пусковой ток (А) EN	920
Длина (мм) [L]	344
Ширина (мм) [W]	175
Высота (мм) [H]	233
Вес (кг) +/- 10%	24,5
Система связи	2 (право +)
концы	1
монтаж	B01
Индикатор заряда	x
Зарядный ток	Прибл. 1/10 от номинальной мощности
Зарядное напряжение	14,8 V
Тип / Технология	Кислота-свинец (Ca-Ca) / X-Classe

*Замена по умолчанию Varta: - (Проверить)

MASTER-SPORT Automobiltechnik (MS) GmbH
Leopoldstr. 244 80807 München
Tel: +48 18 35 35 475 E-mail: sekretariat@master-sport.de



ISO 9001



ISO IATF 16949*



CERTIFIED



AEO



CERTIFIED



www.tecdoc.de



www.teccom.de

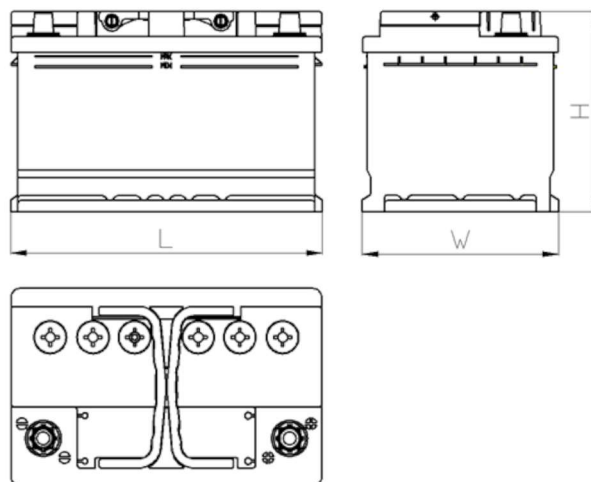

Dátový hárok

Katalógové číslo	761259202
Technické údaje	
Kapacita (Ah)	125Ah
Napätie (V)	12V
Štartovací prúd (A) EN	920
Dĺžka (mm)	344
Šírka (mm)	175
Výška (mm)	233
Hmotnosť (kg) +/- 10%	24,5
Systém pripojenia	2 (Pravo +)
Koncovky	1
Montážne	B01
Indikátor nabitia	x
Nabíjací prúd	Ok. 1/10 menovitej kapacity
Nabíjacie napätie	14,8 V
Typ / technológia	Kyselinovo - olovovy (Ca-Ca) / X-Classe

*PREDVOLENÁ VÝMENA Varta: - (Check)

MASTER-SPORT Automobiltechnik (MS) GmbH
Leopoldstr. 244 80807 München
Tel: +48 18 35 35 475 E-mail: sekretariat@master-sport.de



ISO 9001



ISO IATF 16949*



CERTIFIED



AEO



CERTIFIED



www.tecdoc.de



www.teccom.de