

## KARTA PRODUKTU

Numer Katalogowy	761458509
Dane Techniczne	
Pojemność (Ah)	145Ah
Napięcie (V)	12V
Prąd rozruchowy (A)EN	850
Długość (mm) [L]	513
Szerokość (mm) [W]	189
Wysokość (mm) [H]	217
Waga (kg) +/- 10%	35,5
Układ połączeń	9 (Prawo +)
Końcówki	1
Mocowanie	B00
Wskaźnik naładowania	x
Prąd ładowania	Ok. 1/10 pojemności znamionowej
Napięcie ładowania	14,8 V
Typ/ Technologia	Kwasowo-ołowiowy (Ca-Ca) / X-Classe

\*DOMYŚLNY ZAMIENNIK Varta: 645400080A722 (Sprawdź)

MASTER-SPORT Automobiltechnik (MS) GmbH  
Leopoldstr. 244 80807 München  
Tel: +48 18 35 35 475 E-mail: sekretariat@master-sport.de



ISO 9001



ISO IATF 16949\*



CERTIFIED



AEO



CERTIFIED



www.tecdoc.de



www.teccom.de

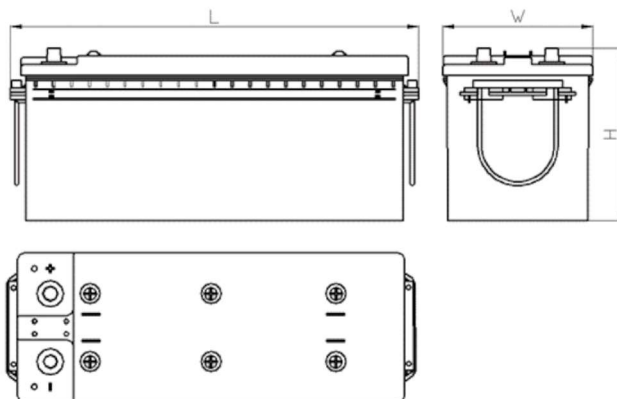

## TECHNICAL DATA SHEET

Catalog number	761458509
TECHNICAL DATA	
Capacity (Ah)	145Ah
Voltage (V)	12V
Cold cranking performance (A)EN	850
Length (mm) [L]	513
Width (mm) [W]	189
Height (mm) [H]	217
Weight (kg) +/- 10%	35,5
Connection layout	9 (Right +)
Tips	1
Base hold-down	B00
Charge indicator	x
Charging current	Approx. 1/10 Rated Capacity
Charging voltage	14,8 V
Type / Technology	Lead-Acid (Ca-Ca) / X-Classe

\*DEFAULT REPLACEMENT Varta: 645400080A722 (Check)

MASTER-SPORT Automobiltechnik (MS) GmbH  
Leopoldstr. 244 80807 München  
Tel: +48 18 35 35 475 E-mail: sekretariat@master-sport.de



ISO 9001



ISO IATF 16949\*



CERTIFIED



AEO



CERTIFIED



www.tecdoc.de



www.teccom.de

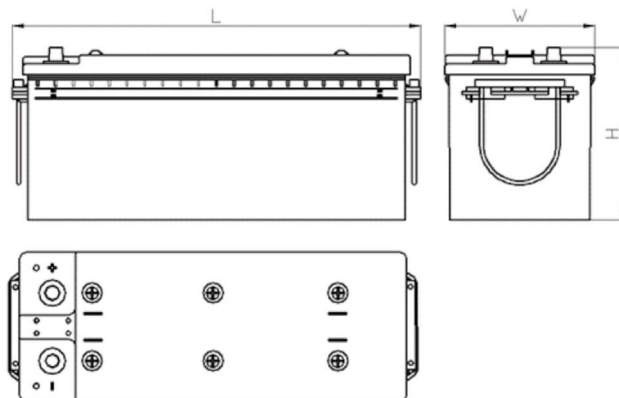

## TECHNISCHES DATENBLATT

Nummer	761458509
TECHNISCHE DATEN	
Nennkapazität (Ah)	145Ah
Nennspannung (V)	12V
Kaltstartstrom (A)EN	850
Länge (mm) [L]	513
Szerokość (mm) [W]	189
Höhe (mm) [H]	217
Batteriegewicht (kg ) +/- 10%	35,5
Polausführung	9 (Rechts +)
Schaltung	1
Bodenleiste	B00
Ladeanzeige	x
Ladestrom	Ca. 1/10 Nennkapazität
Ladespannung	14,8 V
Typ / Technologie	Blei-Säure-Batterie (Ca-Ca) / X-Classe

\*STANDARD-ERSATZ Varta: 645400080A722 (Scheck)

MASTER-SPORT Automobiltechnik (MS) GmbH  
Leopoldstr. 244 80807 München  
Tel: +48 18 35 35 475 E-mail: sekretariat@master-sport.de



ISO 9001



ISO IATF 16949\*



CERTIFIED



AEO



CERTIFIED



www.tecdoc.de



www.teccom.de

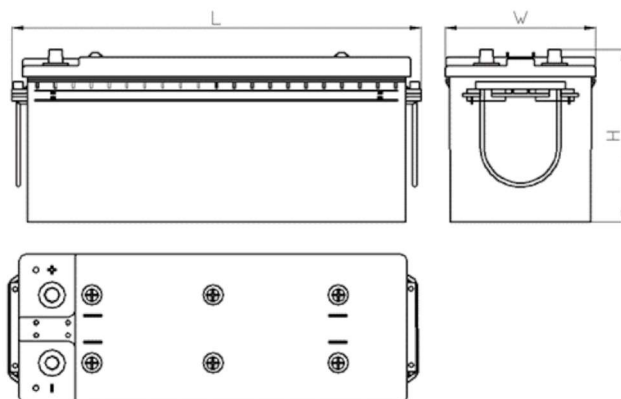

## SCHEDA PRODOTTO

Numero di catalogo	761458509
Dati tecnici	
Capacità (Ah)	145Ah
Tensione (V)	12V
Spunto (A)EN	850
Lunghezza (mm) [L]	513
Larghezza (mm) [W]	189
Altezza (mm) [H]	217
Peso (kg ) +/- 10%	35,5
Sistema di connessione	9 (Destra +)
Estremità	1
Montaggio	B00
Indicatore di carica	x
Corrente di carica	Circa 1/10 Capacità nominale
Tensione di carica	14,8 V
Tipo / Tecnologia	al Piombo-Acido (Ca-Ca) / X-Classe

\*Sostituto Varta: 645400080A722 (Controllare)

MASTER-SPORT Automobiltechnik (MS) GmbH  
Leopoldstr. 244 80807 München  
Tel: +48 18 35 35 475 E-mail: sekretariat@master-sport.de



ISO 9001



ISO IATF 16949\*



CERTIFIED



AEO



CERTIFIED



www.tecdoc.de



www.teccom.de

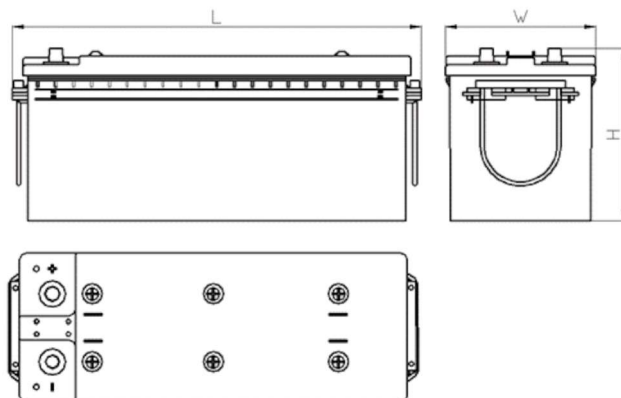

## Технические характеристики

Каталожный номер	761458509
Технические данные	
Емкость (Ач)	145Ah
Напряжение (В)	12V
Пусковой ток (А) EN	850
Длина (мм) [L]	513
Ширина (мм) [W]	189
Высота (мм) [H]	217
Вес (кг) +/- 10%	35,5
Система связи	9 (право +)
концы	1
монтаж	B00
Индикатор заряда	x
Зарядный ток	Прибл. 1/10 от номинальной мощности
Зарядное напряжение	14,8 V
Тип / Технология	Кислота-свинец (Ca-Ca) / X-Classe

\*Замена по умолчанию Varta: 645400080A722 (Проверить)

MASTER-SPORT Automobiltechnik (MS) GmbH  
Leopoldstr. 244 80807 München  
Tel: +48 18 35 35 475 E-mail: sekretariat@master-sport.de



ISO 9001



ISO IATF 16949\*



CERTIFIED



AEO



CERTIFIED



www.tecdoc.de



www.teccom.de

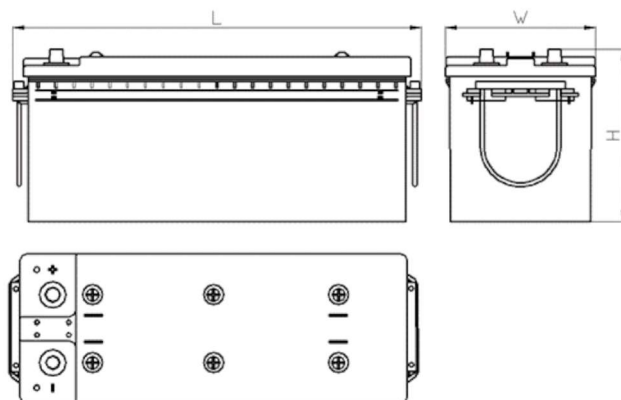

## Dátový hárok

Katalógové číslo	761458509
Technické údaje	
Kapacita (Ah)	145Ah
Napätie (V)	12V
Štartovací prúd (A) EN	850
Dĺžka (mm)	513
Šírka (mm)	189
Výška (mm)	217
Hmotnosť (kg) +/- 10%	35,5
Systém pripojenia	9 (Pravo +)
Koncovky	1
Montážne	B00
Indikátor nabitia	x
Nabíjací prúd	Ok. 1/10 menovitej kapacity
Nabíjacie napätie	14,8 V
Typ / technológia	Kyselinovo -olovovy (Ca-Ca) / X-Classe

\*PREDVOLENÁ VÝMENA Varta: 645400080A722 (Check)

MASTER-SPORT Automobiltechnik (MS) GmbH  
Leopoldstr. 244 80807 München  
Tel: +48 18 35 35 475 E-mail: sekretariat@master-sport.de



ISO 9001



ISO IATF 16949\*



CERTIFIED



AEO



CERTIFIED



www.tecdoc.de



www.teccom.de